



Cert. No. LRQ 0963008

ISO 9001

# spirax sarco

**TI-P045-09**  
 CH Issue 6

## BRV2S5 and BRV2B5 Gunmetal Pressure Reducing Valves

### Description

The **BRV2S5** and **BRV2B5** are direct acting pressure reducing valves designed for applications using steam or gases such as compressed air.

### Available types

**BRV2S5** Stainless steel bellows

**BRV2B5** Phosphor bronze/brass bellows

BRV2S5 and BRV2B5 pressure reducing valves are supplied with one of three colour coded springs which are identified by the disc (18) located on the adjustment handwheel; **Note:** where control spring ranges overlap always use the lower range to give better control:

**Grey** For downstream pressure control: 0.14 to 1.7 bar g

**Green** For downstream pressure control: 1.40 to 4.0 bar g

**Orange** For downstream pressure control: 3.50 to 8.6 bar g

### Standards

This product fully complies with requirements of the European Pressure Equipment Directive 97/23/EC.

### Certification

This product is available with a manufacturers' Typical Test Report. **Note:** All certification/inspection requirements must be stated at the time of order placement.

### Sizes and pipe connections

½", ¾" and 1" screwed BSP (BS 21) or NPT

### Pressure/temperature limits

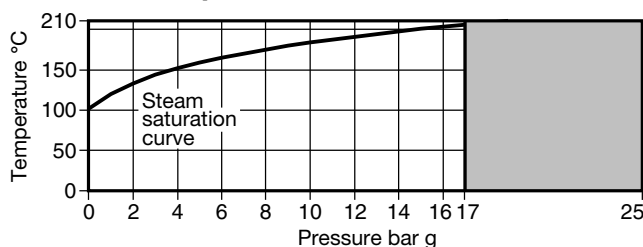

The product **must not** be used in this region.

Body design conditions	PN25
Maximum allowable pressure	25 bar g @ 120°C
Maximum allowable temperature	210°C @ 17 bar g
Minimum allowable temperature	0°C
Maximum operating pressure for saturated steam service	17 bar g @ 210°C
Maximum operating temperature	210°C @ 17 bar g
Minimum operating temperature	0°C
<b>Note:</b> For lower operating temperatures consult Spirax Sarco.	
Maximum downstream reduced pressure	8.6 bar g
Maximum differential pressure	17 bar
Maximum recommended turndown ratio 10:1 at maximum flow	

Designed for a maximum cold hydraulic test pressure of 38 bar g  
**Note:** With internals fitted, test pressure must not exceed 17 bar g

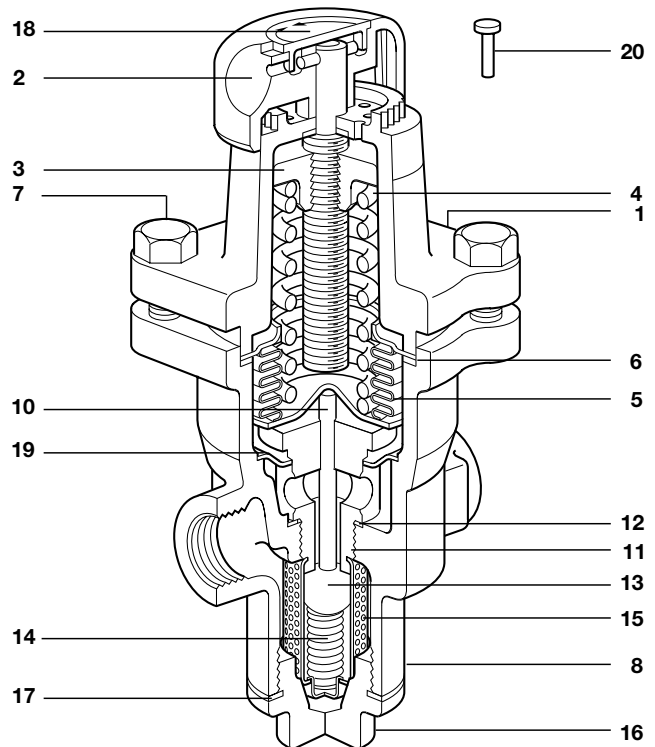

### Materials

No.	Part	Materials
1	Spring housing	Aluminium epoxy coated LM 24
2	Adjustment handwheel	Polypropylene
3	Top spring plate	Cast iron DIN 1691 GG 20
4	Pressure adjustment spring	Silicon chrome BS 2803 685 A55 spring steel Range 2
5	Bellows assembly	Stainless steel 316Ti/316L Phosphor bronze BS 2872 CZ 122
6	Bellows assembly gasket	Stainless steel reinforced exfoliated graphite
7	Hex. bolt (M8 x 25 mm)	Steel zinc plated BS 3692 Gr. 8.8
8	Body	Gunmetal BS EN 1982 CC491K or BS 1400 LG2
10	Pushrod	Stainless steel ASTM A276 316L
11	Valve seat	Stainless steel BS 970 431 S29
12	Valve seat gasket	Stainless steel BS 1449 316 S11
13	Valve	Stainless steel AISI 420
14	Valve return spring	Stainless steel BS 20056 316 S42
15	Strainer screen	Stainless steel BS 1449 316 SH
16	Cap	Brass BS 2872 CZ 122
17	Cap gasket	Stainless steel reinforced exfoliated graphite
18	Spring range ID disc	Polypropylene
19	Bulkhead plate	Stainless steel 316L
20	Tamper-proof pin	Mild steel copper plated

**Note:** Items 10, 11, 13, 14, 15 and 19 are all part of one assembly.

### Capacities for safety valve sizing

Full lift capacities for safety valve sizing purposes :	Size Kvs	DN15 1.5	DN20 2.5	DN25 3.0
---------------------------------------------------------	-------------	-------------	-------------	-------------

For conversions:  $C_V (UK) = K_V \times 0.963$      $C_V (US) = K_V \times 1.156$

### Steam and compressed air capacities

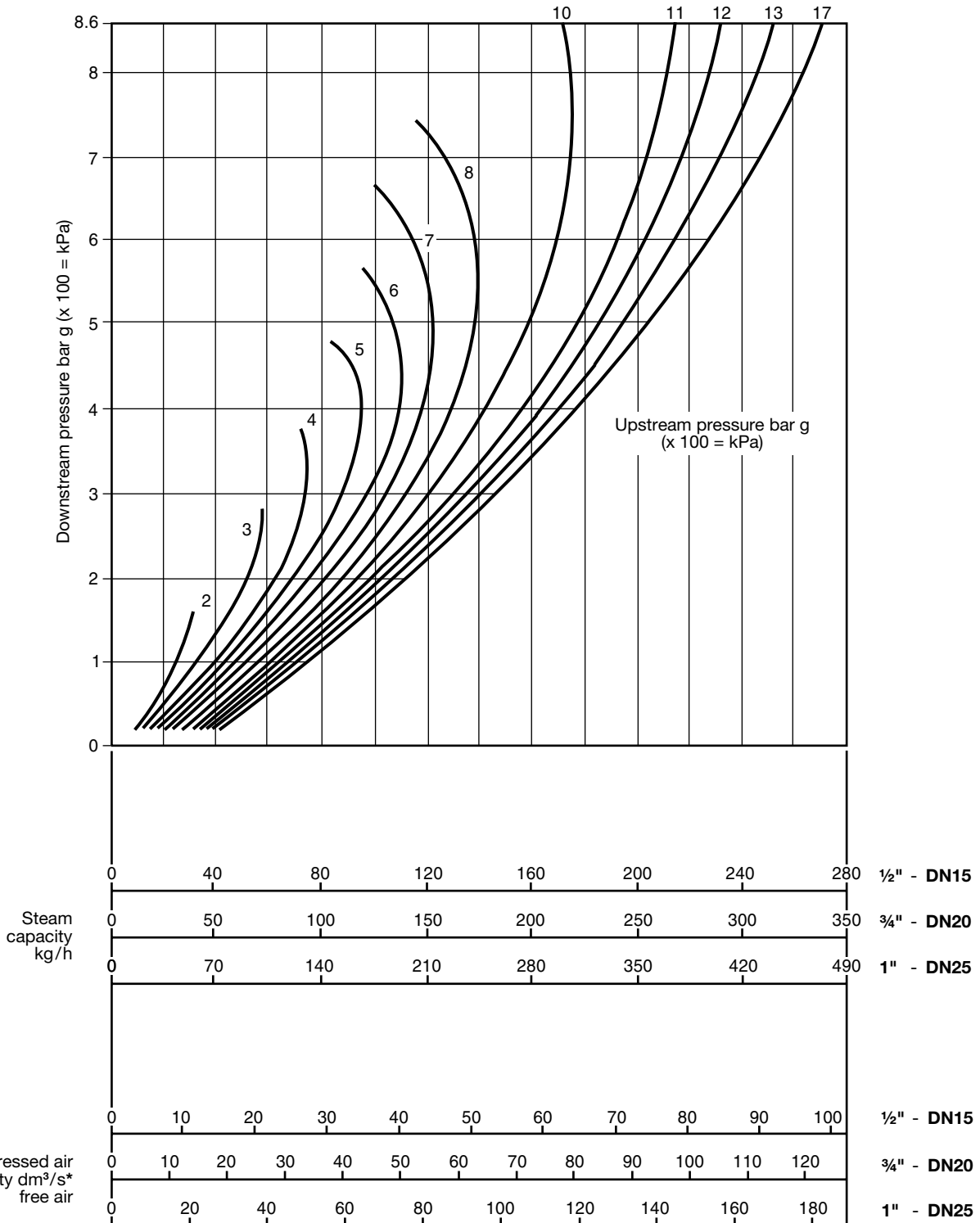

\*  $dm^3/s = l/s$ ,  $1 l/s \approx 2 c.f.m.$

### How to use the chart

The curved lines labelled 2, 3, 4, 5 etc., represent upstream pressures. Downstream pressures are read along the vertical line on the left hand side of the chart.

#### How to use the chart is best described by an example:-

Required, a pressure reducing valve to pass 120 kg/h reducing from 8 to 6 bar. From the downstream pressure of 6 bar on the left hand side of the chart extend out horizontally until the line meets the curved 8 bar upstream line. At this point read vertically downwards where it will be seen that either a 1/2" BRV2S5 or BRV2B5 will be required.

**Dimensions / weight (approximate) in mm and kg**

Size	A	B	C	D	E	F	Weight
1/2"	83	32	62	130	25	40	2
3/4"	96	32	62	130	25	40	2
1"	108	32	62	130	25	40	2

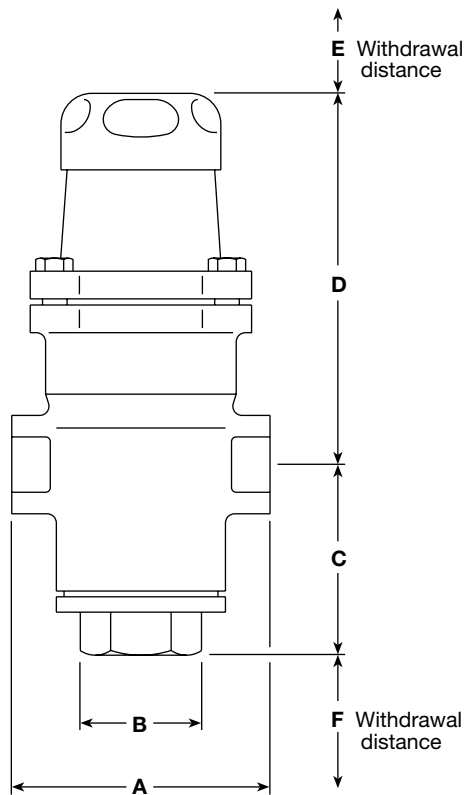

**Spare parts**

The spare parts available are shown in solid outline. Parts drawn in broken line are not supplied as spares.

**Available spares**

* Pressure adjustment spring	Grey	0.14 to 1.7 bar g	<b>4, 18</b>
	Green	1.40 to 4.0 bar g	<b>4, 18</b>
	Orange	3.50 to 8.6 bar g	<b>4, 18</b>
* Bellows assembly specify type	Stainless steel or phosphor bronze		<b>5, 6</b>
* Spring housing hex. bolts (set of 4)			<b>7</b>
* Valve and seat assembly			<b>6, 11, 12, 19</b>
* Gasket set			<b>6, 12, 17</b>
* Common to all sizes.			

**How to order spares**

Always order spares by using the description given in the column headed 'Available spares' and state the size, type and pressure range of the reducing valve.

**Example:** 1 off Pressure adjustment spring (orange), having a downstream pressure range of 3.5 to 8.6 bar g for a Spirax Sarco 1/2" BRV2S5 pressure reducing valve.

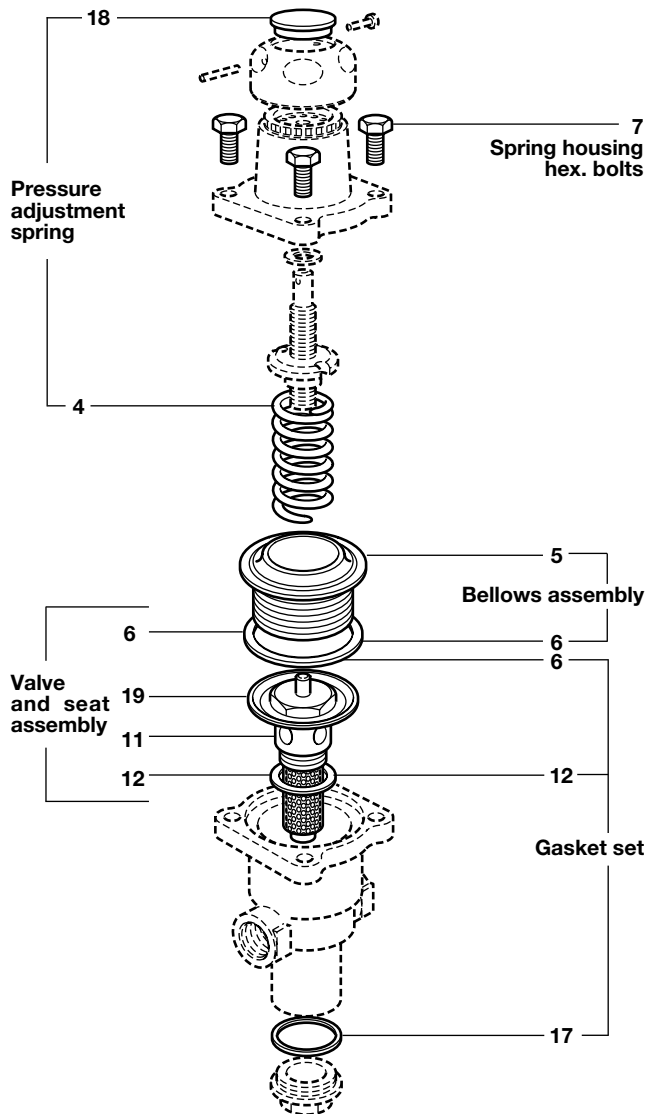

**Safety information, installation and maintenance**

For full details see the Installation and Maintenance Instructions (IM-P045-11) supplied with the product.



**Installation note:**

The valve should be installed in a horizontal pipeline with the direction of flow as indicated by the arrow on the valve body.

**How to order**

**Example:** 1 off Spirax Sarco 1/2" BRV2S5 pressure reducing valve with gunmetal body, screwed BSP connections, stainless steel bellows and fitted with an orange spring for downstream pressure control of 3.5 to 8.6 bar g.

**Recommended tightening torques**

Item no.	Part	 or 	mm	N m
7	Hex. bolts	13 A/F	M8 x 25	18 - 24
11	Valve seat	32 A/F		108 - 132
16	Bottom cap	32 A/F		65 - 75